

16 MEGA-PIXEL 8/10/12 BIT, 3 FPS, FIELD UPGRADEABLE, PROGRAMMABLE DIGITAL CAMERA

IPX-16M3-L

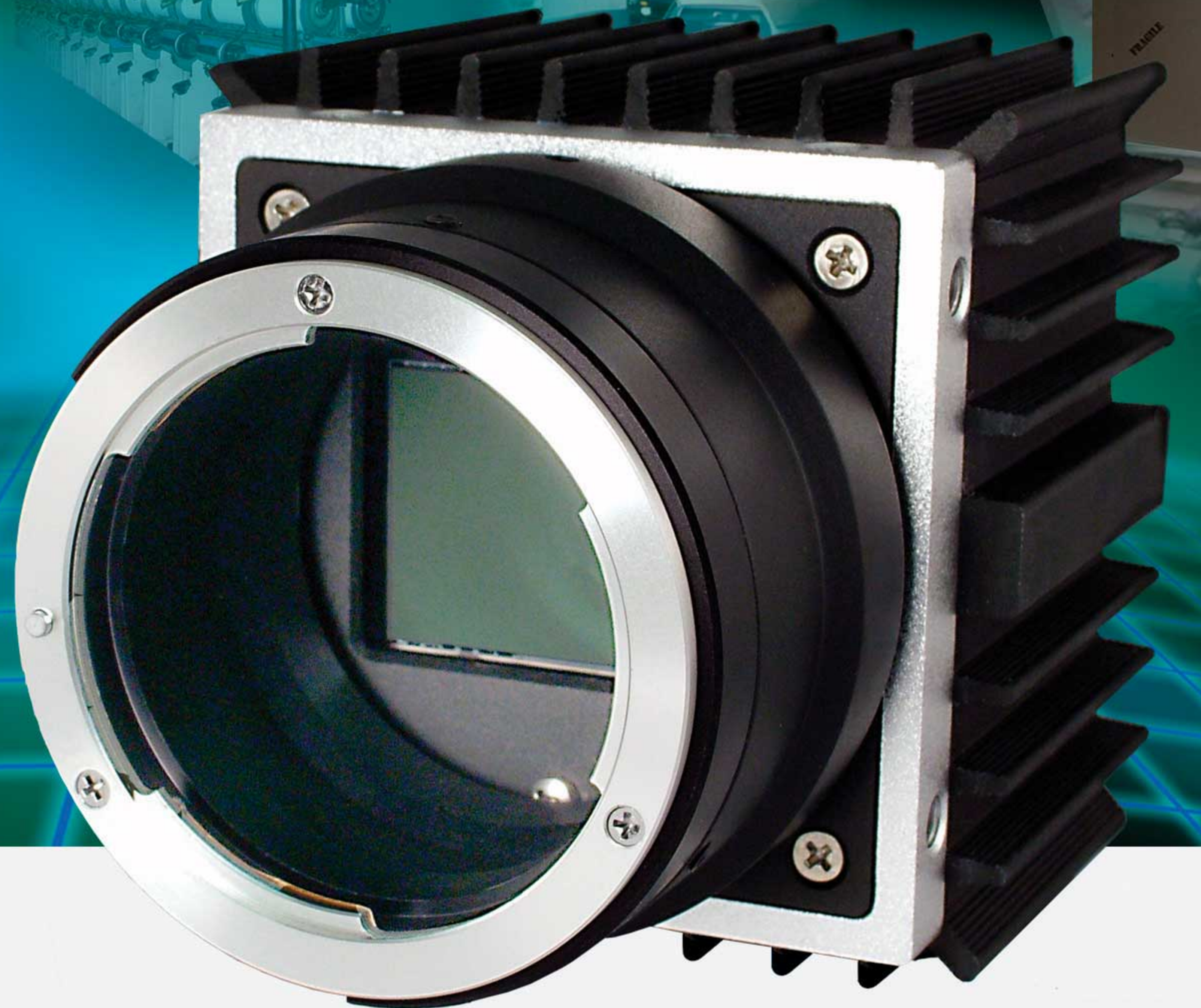

Features

- 4872 x 3248 pixels @ 3 fps
- Mono or Color
- 8/10/12 bit data, Base Camera Link
- Single or Dual tap operation
- RS232 serial communication
- 32 bit RISC processor
- Horizontal and vertical binning
- Highly programmable:
 - resolution • frame rate
 - electronic shutter • long integration
 - external trigger • pre-exposure
 - fast triggering • double exposure
 - strobe output • gain and offset
 - area of interest • user LUT
- Dynamic Transfer Function correction
- Dynamic Black Level Compensation
- Temperature monitor
- Field upgradeable:
 - SW • FW • LUT • FFC • DPC
- Defective Pixel Correction
- Flat Field Correction
- Automatic Iris Control - optional

Applications

- Medical and Scientific Imaging
- Machine Vision and Metrology
- Microscopy
- Remote Sensing
- Surveillance



FAST...SMART...FLEXIBLE...
LYNX FAMILY

The **IPX-16M3-L** is an advanced, high-resolution progressive scan, fully programmable and field upgradeable CCD camera, built around KODAK's KAI-16000 interline transfer CCD. The camera provides 4872 x 3248 resolution and delivers 3 frames per second at full resolution. The camera image processing engine is based on a 2 million gate FPGA and 32 bit RISC processor, featuring programmable resolution, AOI, binning, triggering, shutter, long integration, transfer function correction and user LUT. Support for DPC and FFC.

Specifications for IPX-16M3-L

Active Image Pixels	4872 (H) x 3248 (V), Mono or Color
Active Image Area	36.07 mm x 24.05 mm
Pixel size	7.4 μ m
Video Output	Digital, 8/10/12 bit, one or two outputs
Camera Interface	Base Camera Link
Data Clock	28.000 MHz
Resolution	4872 x 3248 pixels max
Frame Rate	3 fps (dual) / 1.5 fps (single), up to 29 fps w/AOI
Shutter Speed	1/1700 sec to 1/1.5 sec
Long Integration	1/1.5 sec to 10 sec
Gamma Correction	G=1.0, G=0.45, User defined LUT
Black Level Offset	256 levels/output
Video Gain	6-40 dB, 1024 steps/output
External Trigger	Asynchronous
Hardware Trigger	External, level sensitive, 3.3V - 5.0V, 10 mA., optically isolated, programmable exposure
Software Trigger	Frame-grabber, CC1, programmable exposure
S/N Ratio	60 dB
Strobe Output	Active HIGH, for external light source
Lens Mount	F mount, 43.3 mm image diagonal
Environmental	Operating: -5 to 50 C, Storage: -10 to 65 C
Min. Illumination	1.0 Lux, f=1.4, no IR cut filter, no shutter
Mechanical	(78 x 78 x 58) mm; 19 oz (540 g)

Power Connector

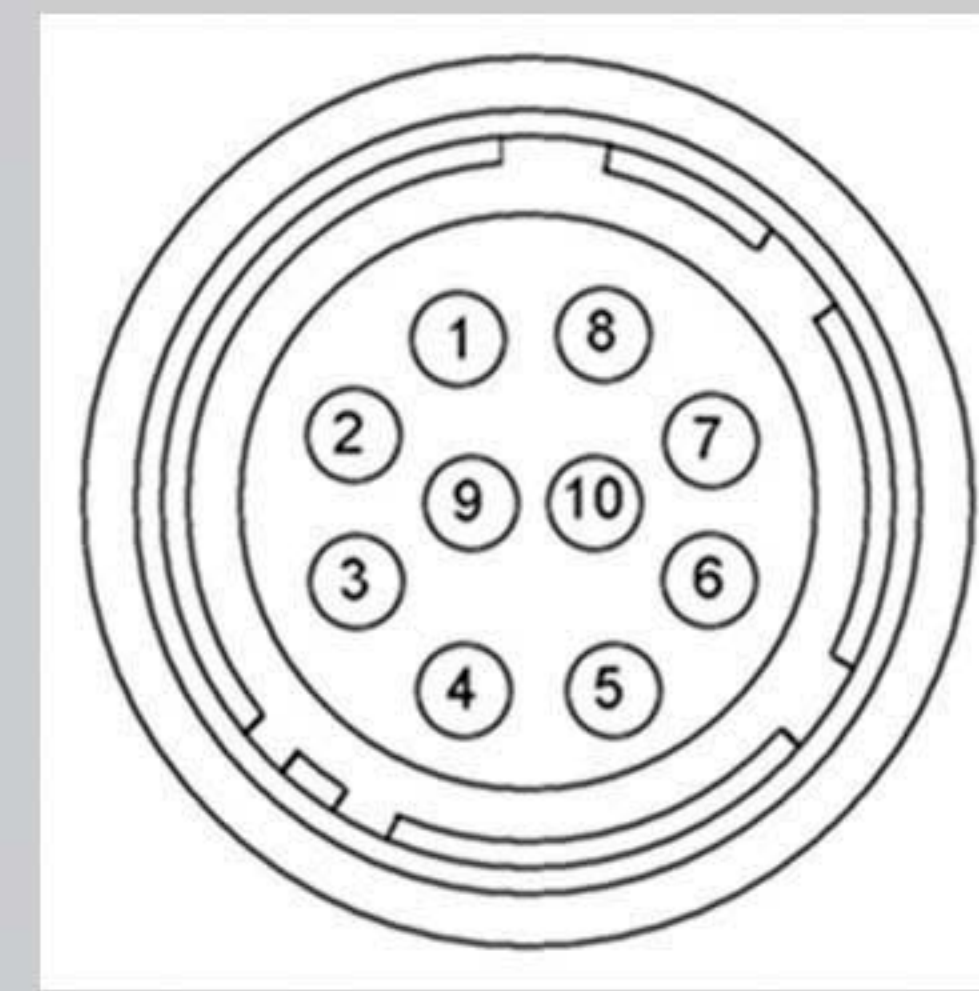

Rear Camera View

- 1 Trigger IN -
- 2 Trigger IN +
- 3 -12 VDC
- 4 -12 VDC
- 5 +12 VDC
- 6 +12 VDC
- 7 Strobe OUT -
- 8 Strobe OUT +
- 9 Auto Iris +
- 10 Auto Iris -

Power Requirements

- 12V DC, (10V min, 15V max)
- 550 mA steady, 1.5 A inrush
- 6.6 W constant power
- Connector: Hirose HR 10A-10R-10P

Mechanical Dimensions

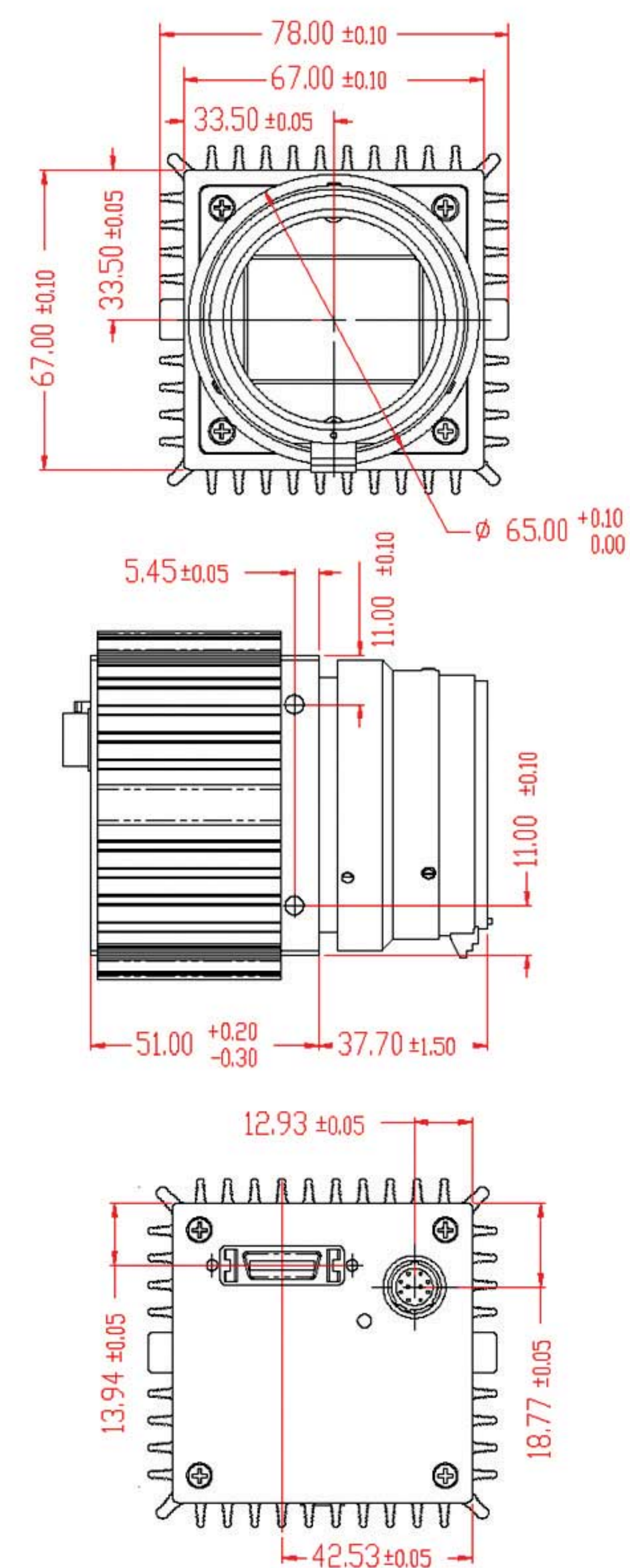

Spectral Response

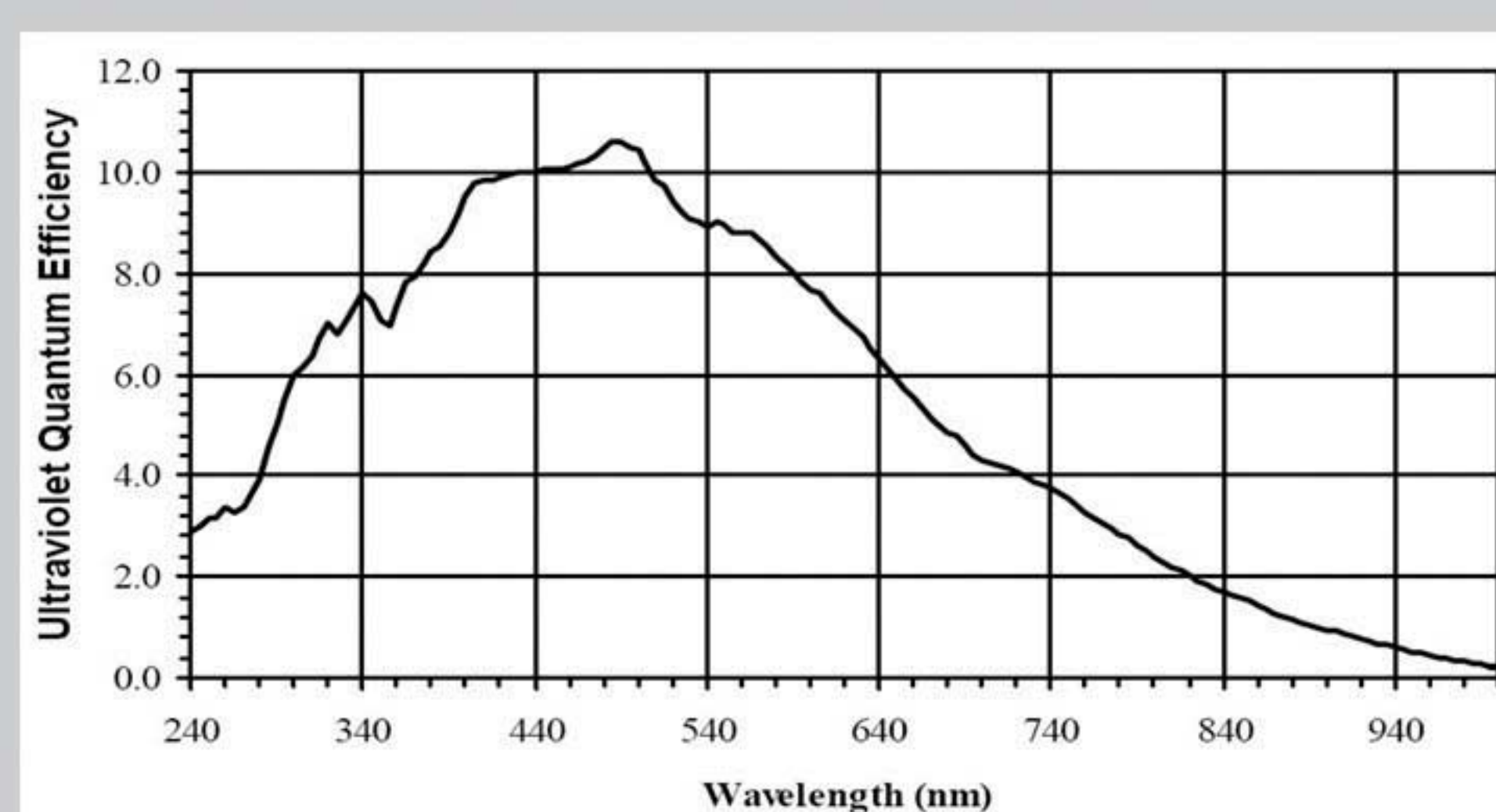
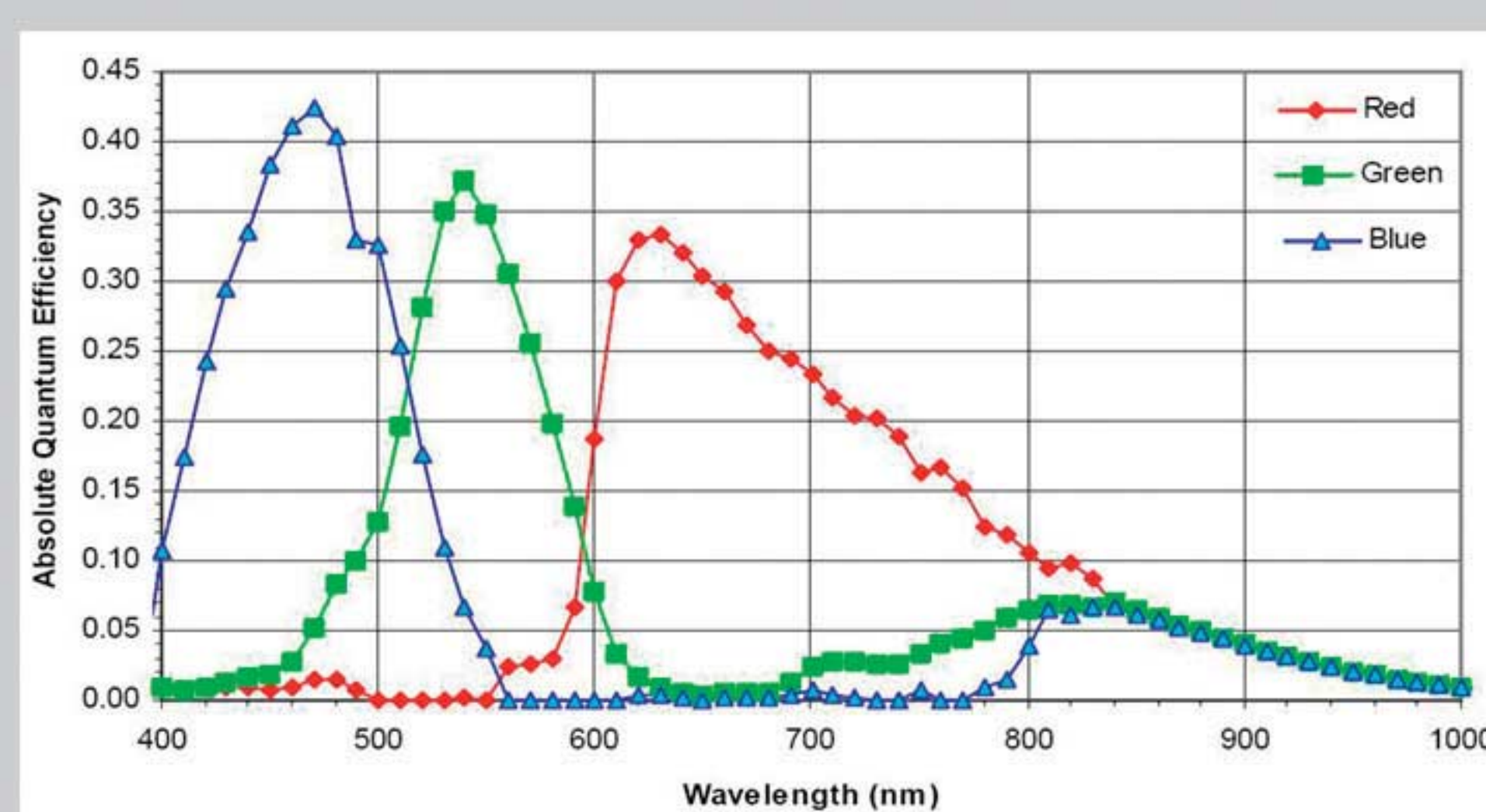
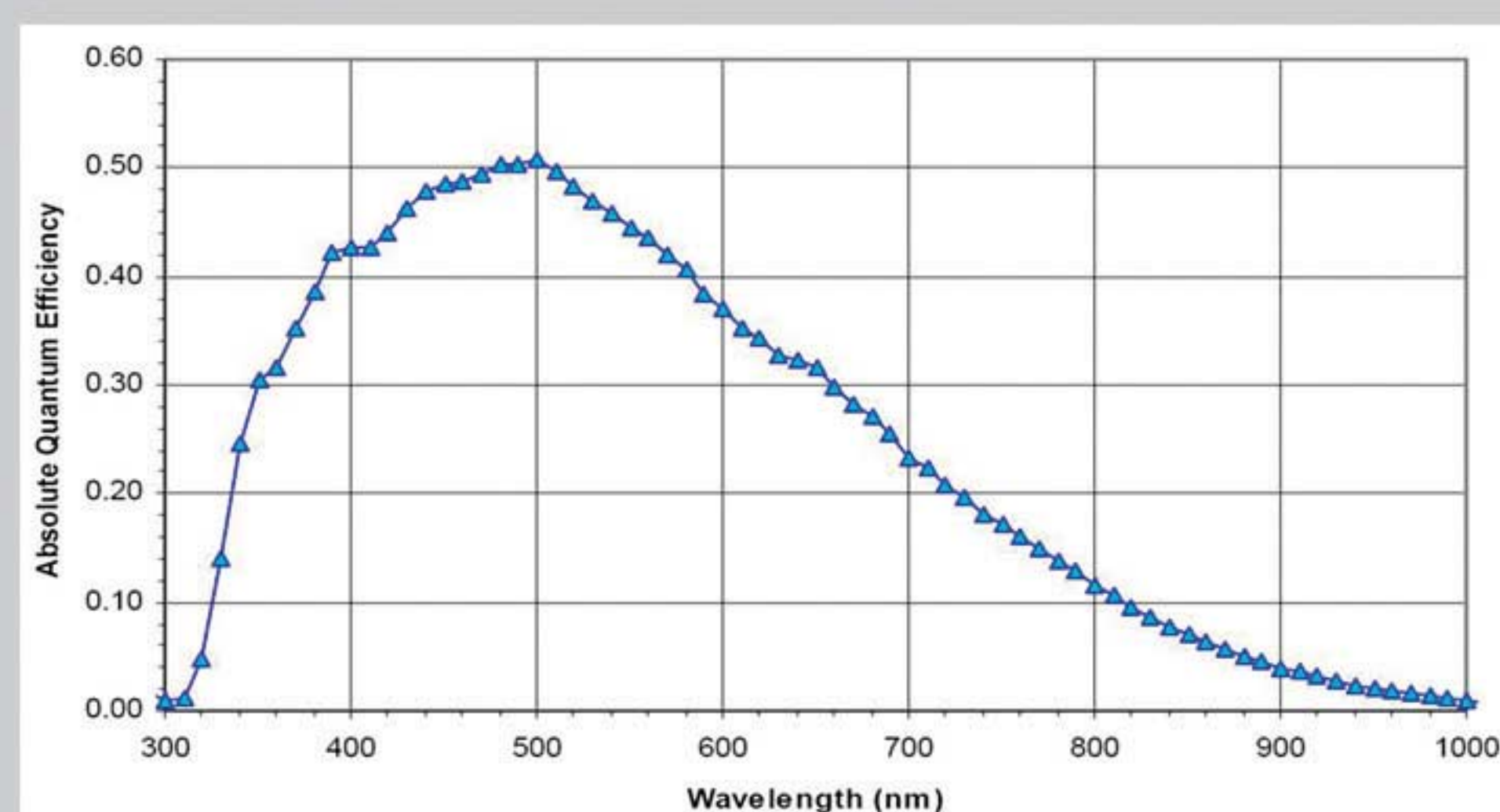

Configuration Utility

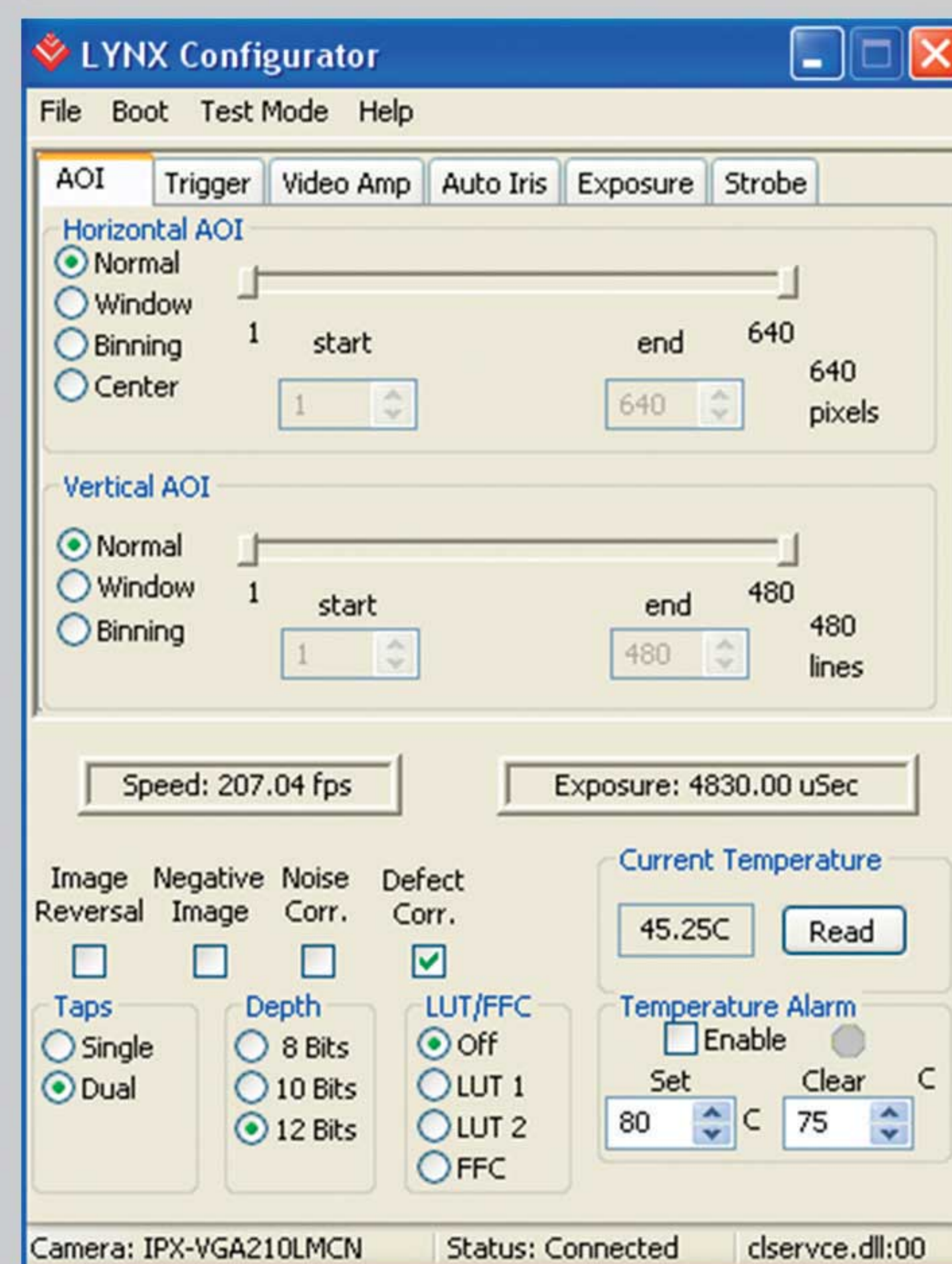

- CameraLink protocol compliant
- Control all camera features via:
 - our intuitive, easy-to-use GUI, or
 - simple ASCII commands

Ordering: IPX-16M3-LMFN

Camera Family	Options
L - LYNX Family	N - silver housing
Sensor Type	B - black housing
M - Monochrome	I - Auto Iris
C - Color	Lens Mount
U - UV sensitive (no glass)	F - "F" mount (default)
S - Special - user filter	O - Open frame

For specific details and ordering information, consult the camera user's manual or contact us at sales@imperx.com.

Copyright © 2005, Imperx, Inc. Product information subject to change without notice.

Rev. 1.0, 10/05/06



Imperx Incorporated • 6421 Congress Avenue • Boca Raton, FL 33487 • USA
 Phone: 1-561-989-0006 • 1-866-849-1662 • Fax: 1-561-989-0045
www.imperx.com • sales@imperx.com

Made in USA

