

1 MEGA-PIXEL 8/10/12 BIT, 48 FPS, FIELD UPGRADEABLE, PROGRAMMABLE DIGITAL CAMERA, GigE OUTPUT

IPX-1M48-G

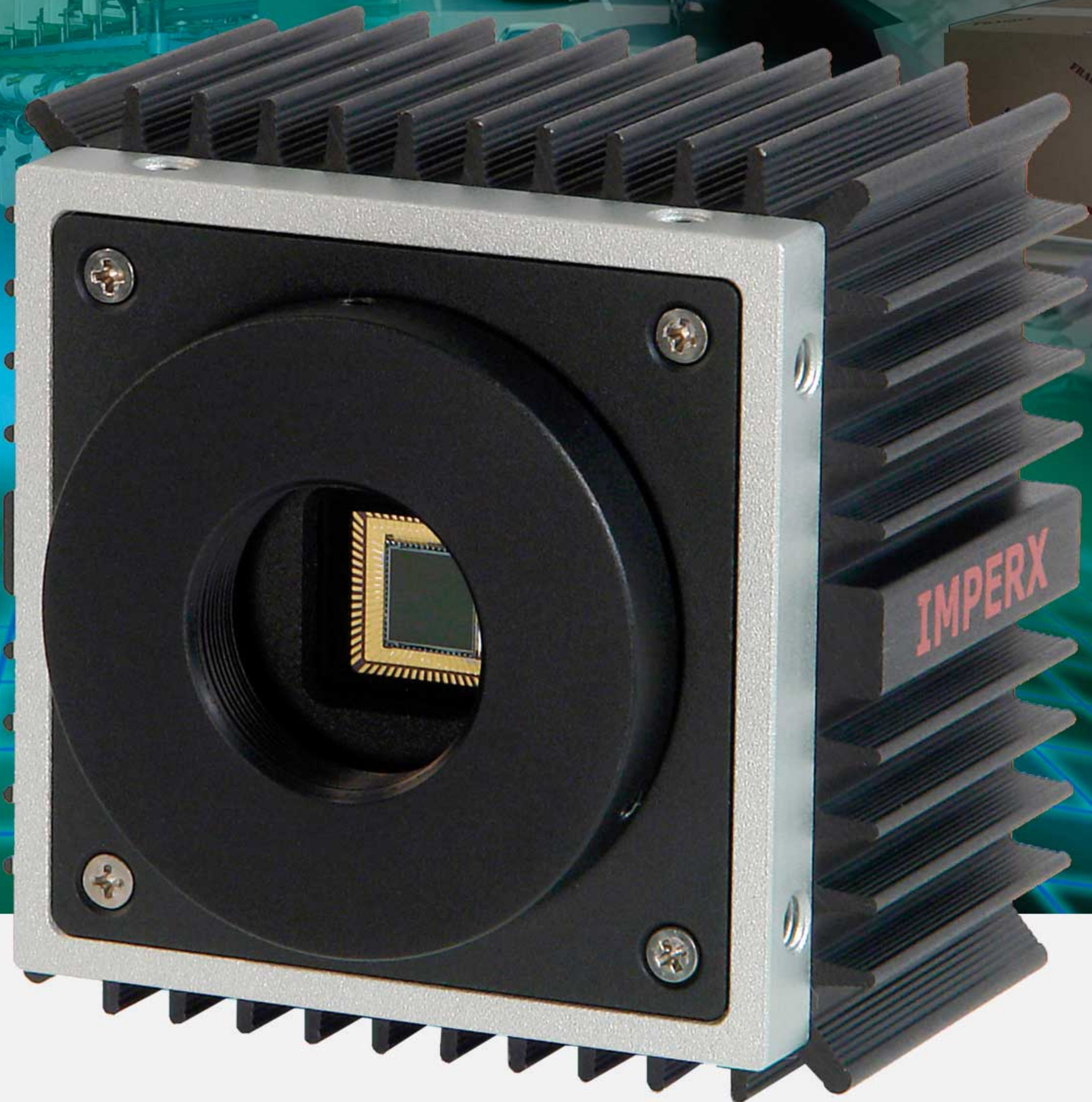

Features

- 1000 x 1000 pixels @ 48 fps
- 8/10/12 bit selectable data output
- GigE Output
- Single or Dual tap operation
- Serial communication
- 32 bit RISC processor
- Horizontal and vertical binning
- Highly programmable:
 - resolution • frame rate
 - electronic shutter • long integration
 - external trigger • pre-exposure
 - synchronized triggering • double exposure
 - strobe output • gain and offset
 - area of interest • user LUT
- Dynamic Transfer Function correction
- Dynamic Black Level Compensation
- Temperature monitor
- Field upgradeable:
 - SW • FW • LUT • DPC
- Defective Pixel Correction
- Automatic Iris Control - optional

Applications

- Medical and Scientific Imaging
- Machine Vision and Metrology
- Microscopy
- Remote Sensing
- Surveillance

The **IPX-1M48-G** is an advanced, high-resolution progressive scan, fully programmable and field upgradeable CCD camera, built around KODAK's KAI-1020 interline transfer CCD. The camera provides 1000 x 1000 resolution and delivers 48 frames per second at full resolution. The camera image processing engine is based on a 1 million gate FPGA and 32 bit RISC processor, featuring programmable resolution, AOI, binning, triggering, shutter, long integration, transfer function correction and user LUT. Support for DPC.

FAST...SMART...FLEXIBLE...
LYNX FAMILY



Specifications for IPX-1M48-G

Active Image Pixels	1000 (H) x 1000 (V), Mono or Color
Active Image Area	7.40 x 7.40 mm
Pixel size	7.4 um
Video Output	Digital, 8/10/12 bit, one or two outputs
Camera Interface	GigE Output
Physical Interface	RJ-45, 802.3, Ethernet v2.0, IP, ICMP, UDP, PING
Data Clock	40.000 MHz
Resolution	1000 x 1000 pixels max
Frame Rate	48fps (dual)/30fps (single), up to 140 fps w/AOI
Shutter Speed	1/50000 sec to 1/30 sec
Long Integration	1/30 sec to 10 sec
Gamma Correction	G=1.0, G=0.45, User defined LUT
Black Level Offset	256 levels/output
Video Gain	0-36 dB, 1024 steps/output
Camera Triggering	Asynchronous, Hardware, Software
Trigger Modes	Programmable, Normal, Double, Fast
Camera Firmware	32 bit RISC, field upgradeable
S/N Ratio	60 dB
Strobe Output	Active HIGH, for external light source
Lens Mount	C mount, 2/3" format
Environmental	Operating: -5 to 50 C, Storage: -10 to 65 C
Min. Illumination	1.0 Lux, f=1.4, no IR cut filter, no shutter
Mechanical	(78 x 78 x 54) mm; 16 oz (450 g)

Power Connector

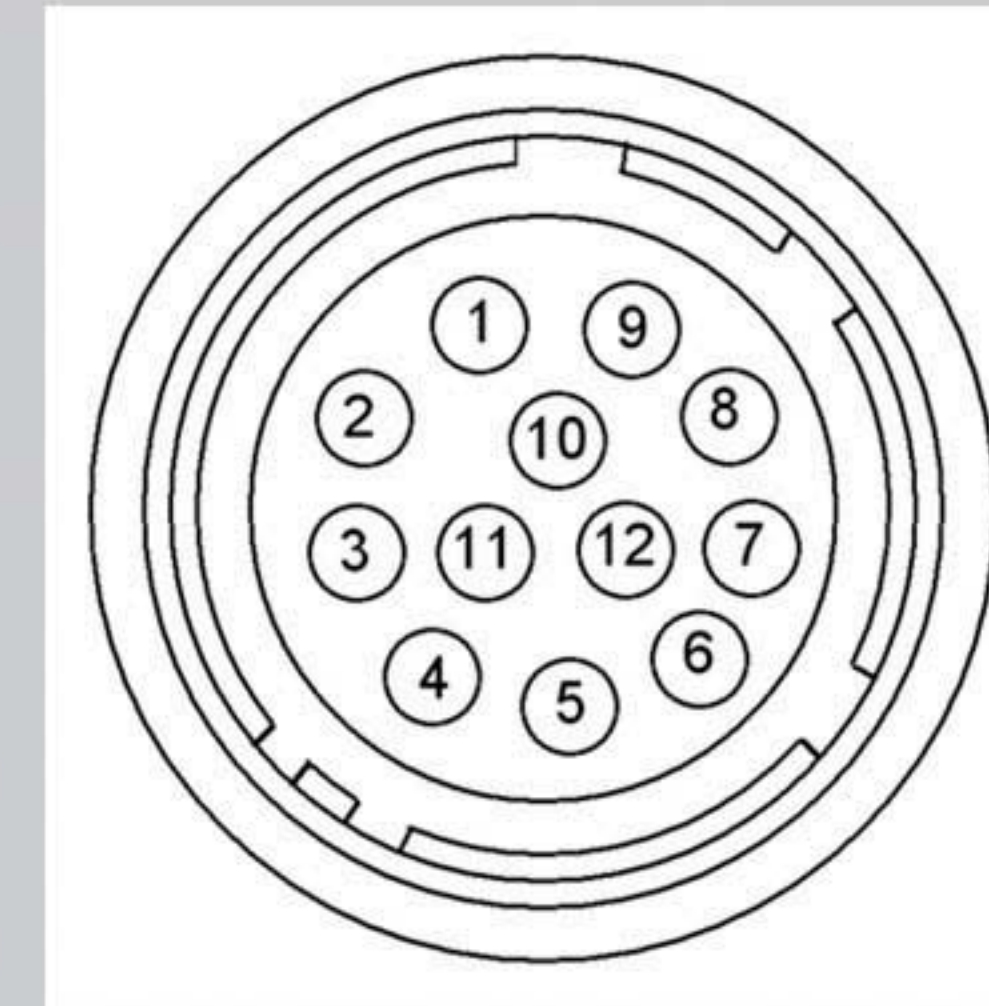

Rear Camera View

- 1 - 12V DC
- 2 +12V DC
- 3 Auto Iris 1
- 4 Auto Iris 2
- 5 Auto Iris GND
- 6 Strobe GND
- 7 Strobe OUT
- 8 Trigger IN
- 9 N/C
- 10 Trigger GND
- 11 N/C
- 12 N/C

Power Requirements

- 12V DC, (10V min, 15V max)
- 550 mA steady, 1.5 A inrush
- 6.6 W constant power
- Connector: Hirose HR 10A-10R-12P

Mechanical Dimensions

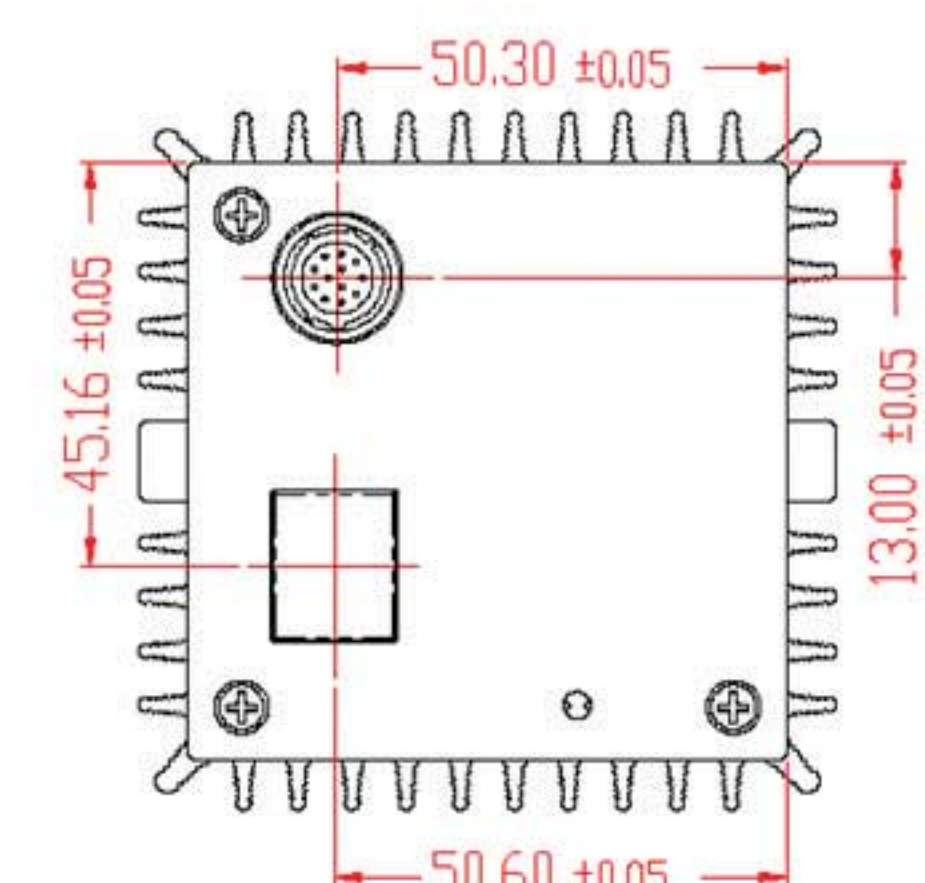
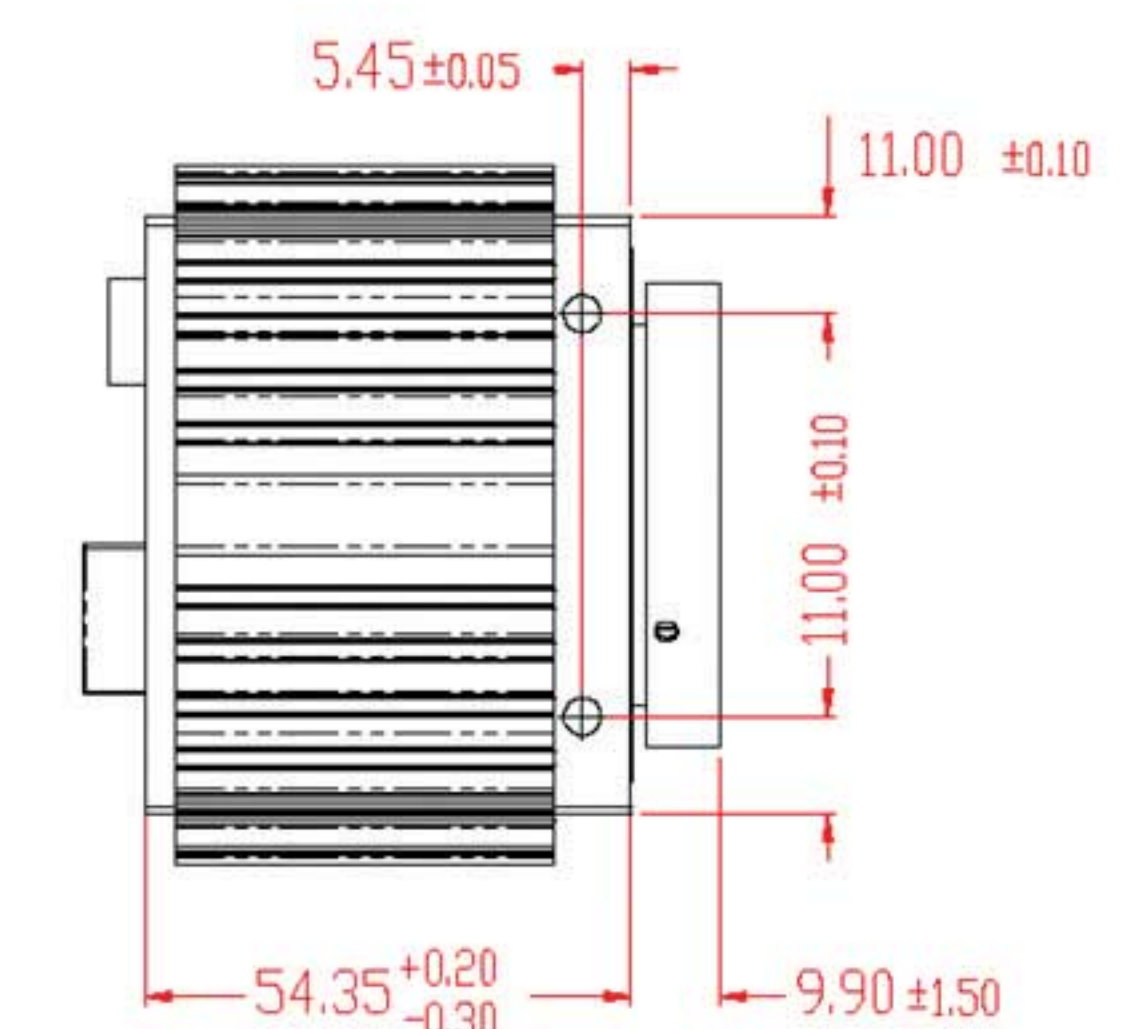
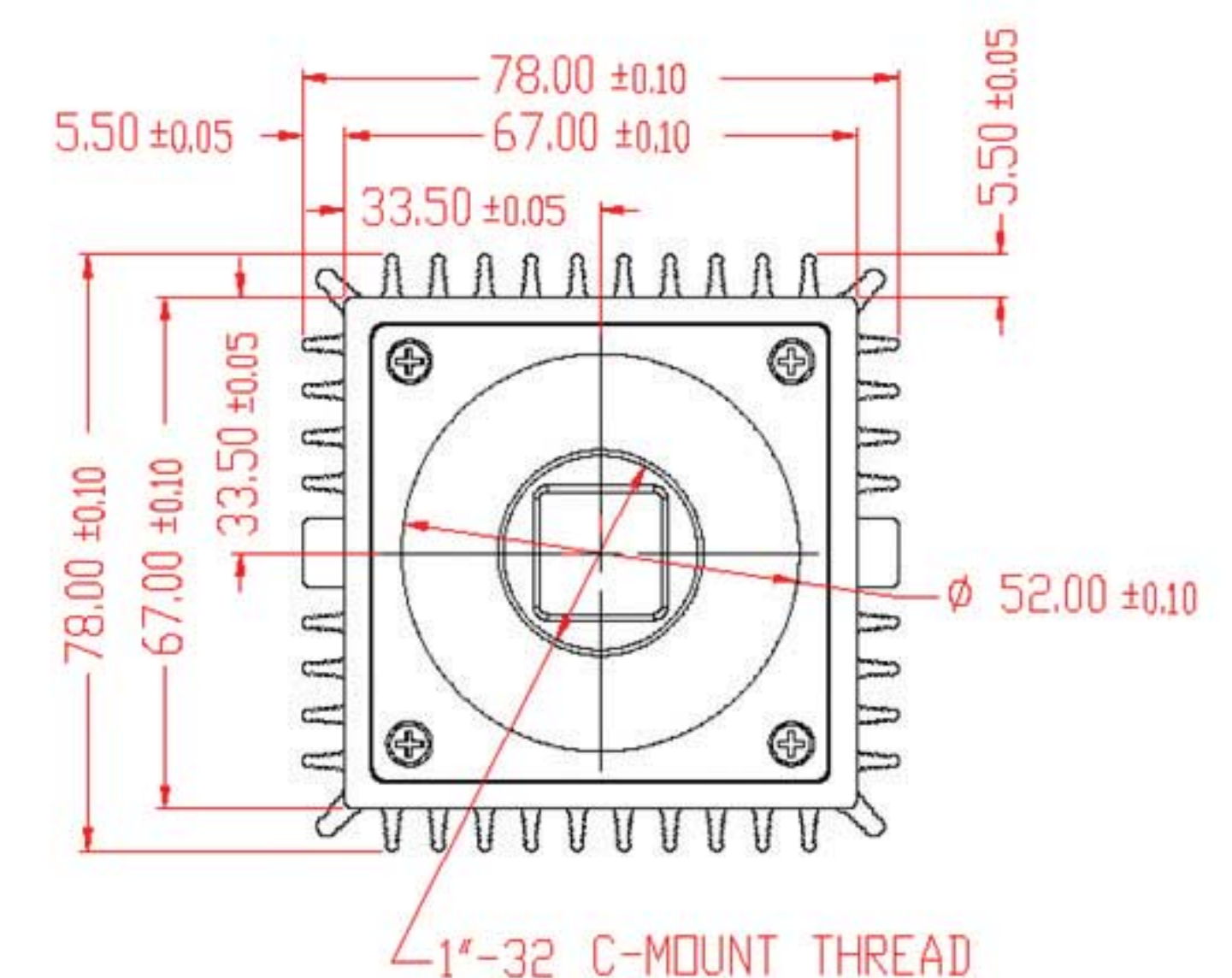

Spectral Response

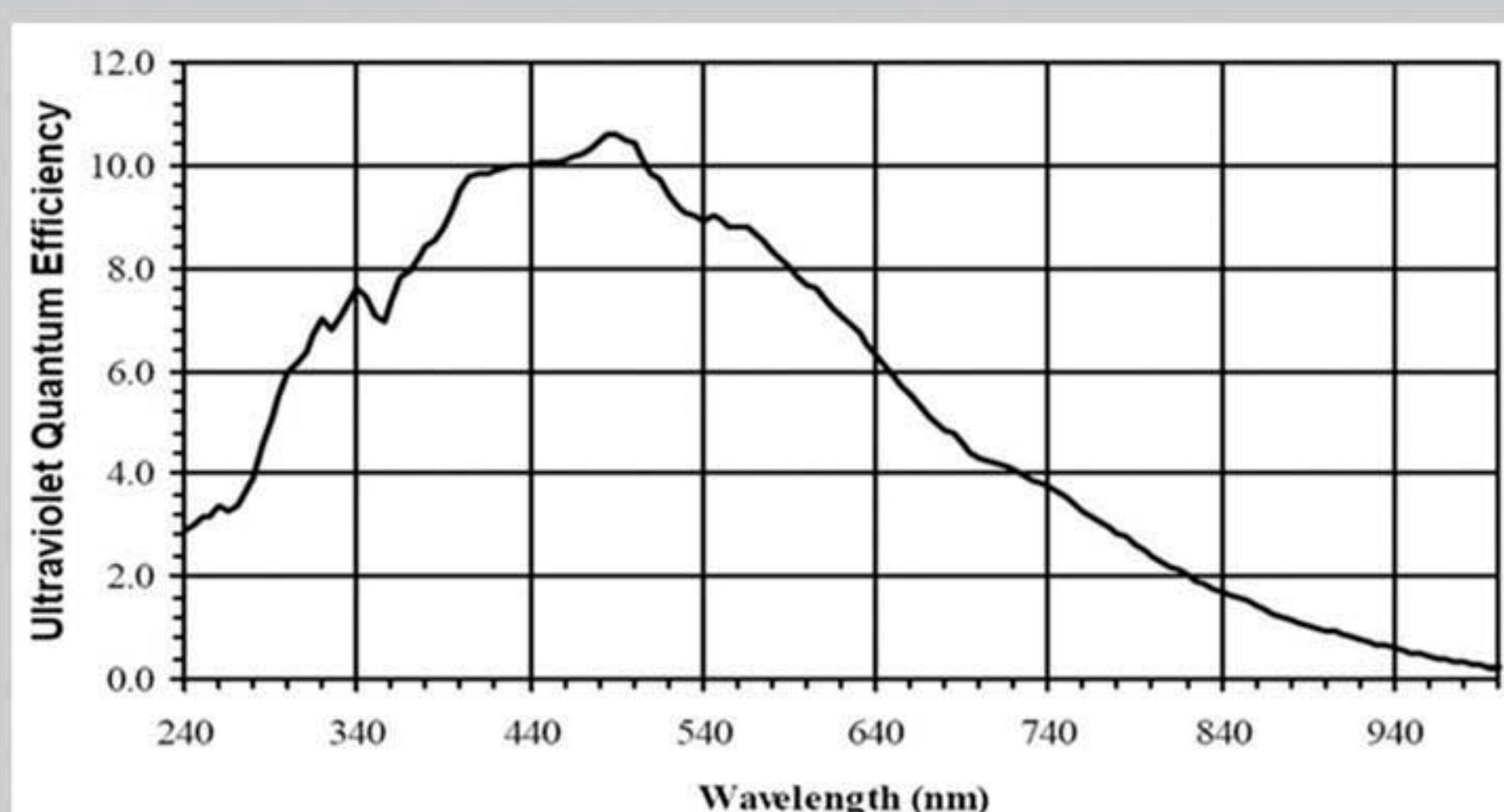
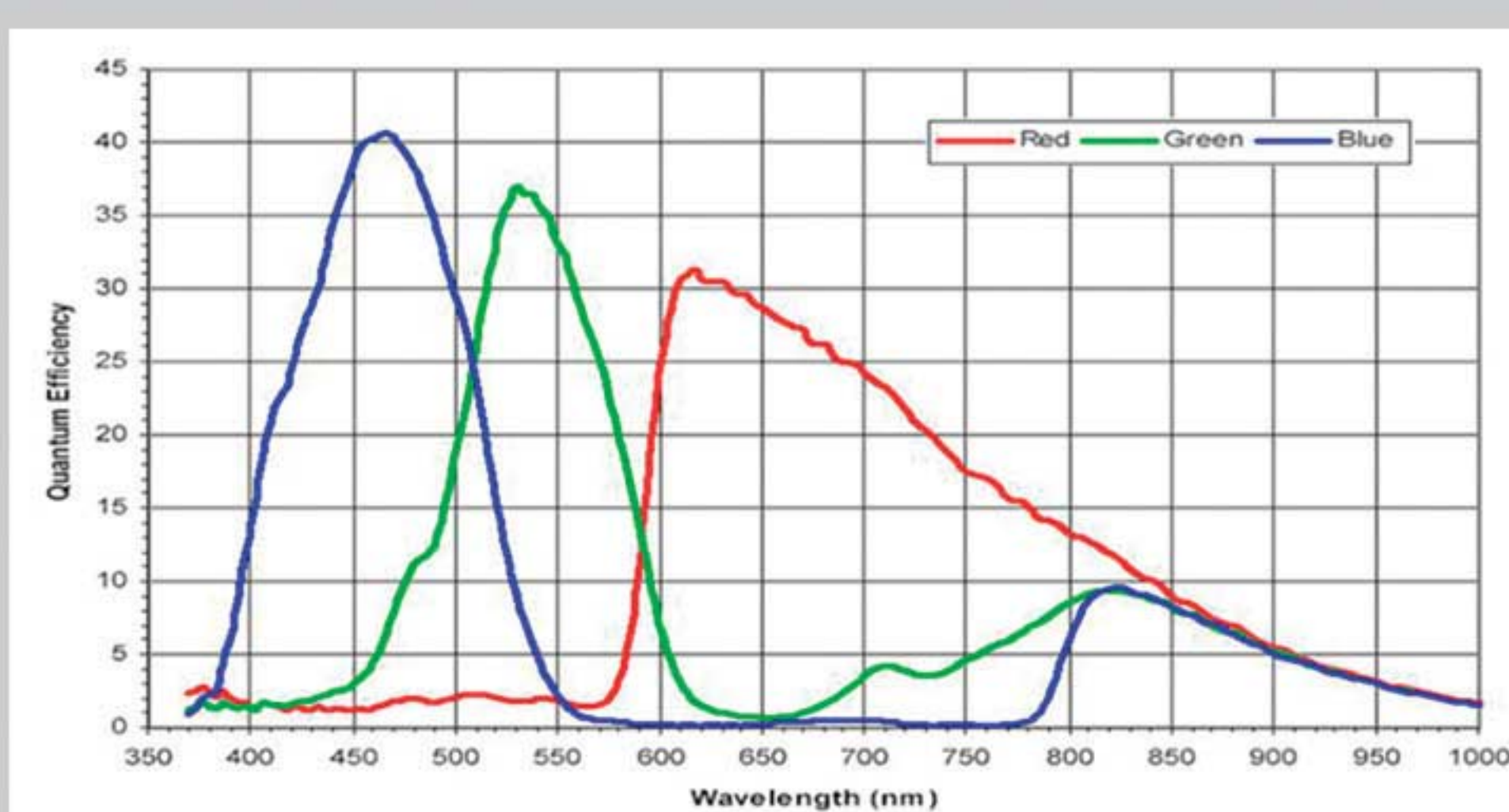
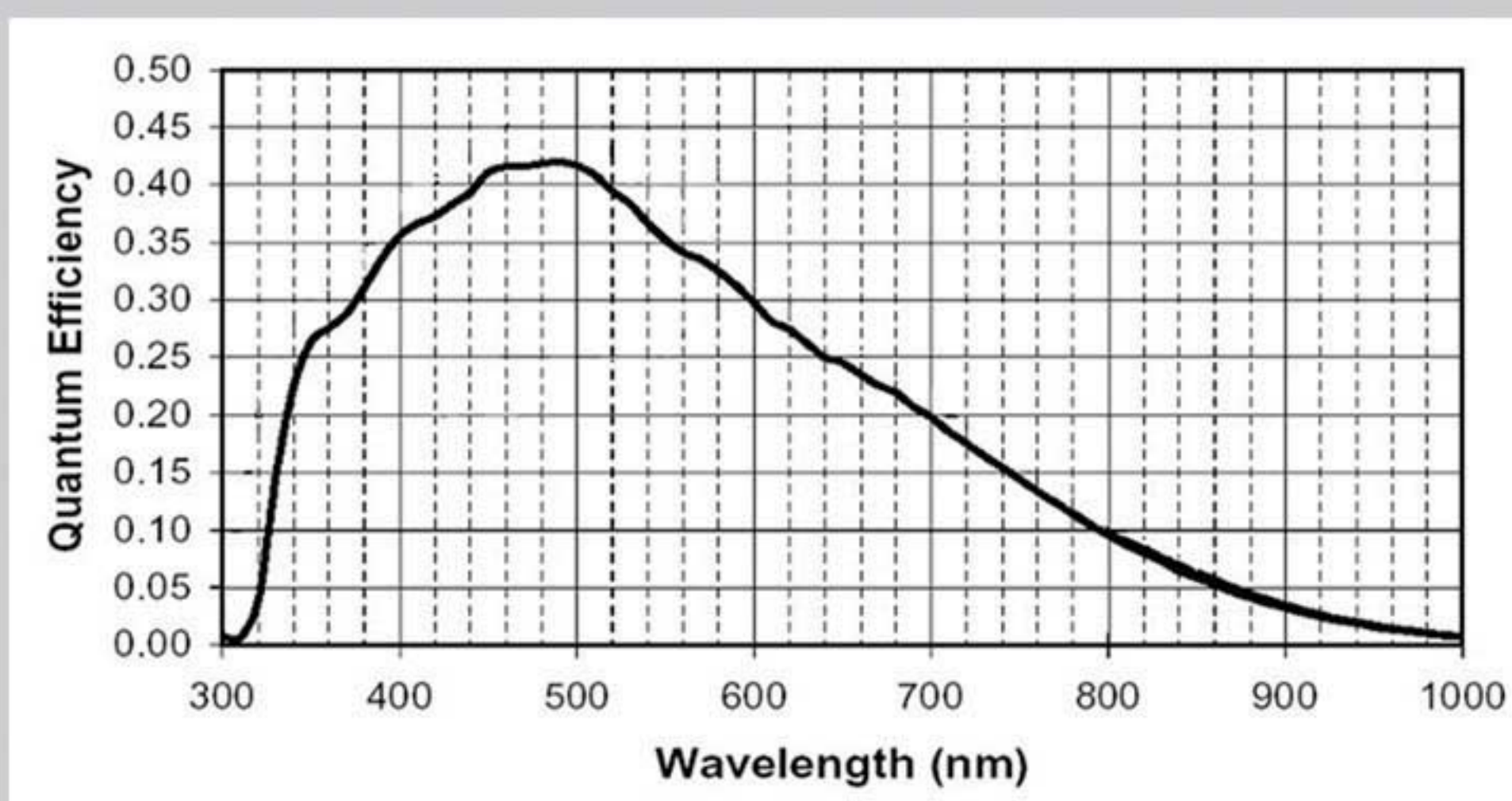

Software Tools

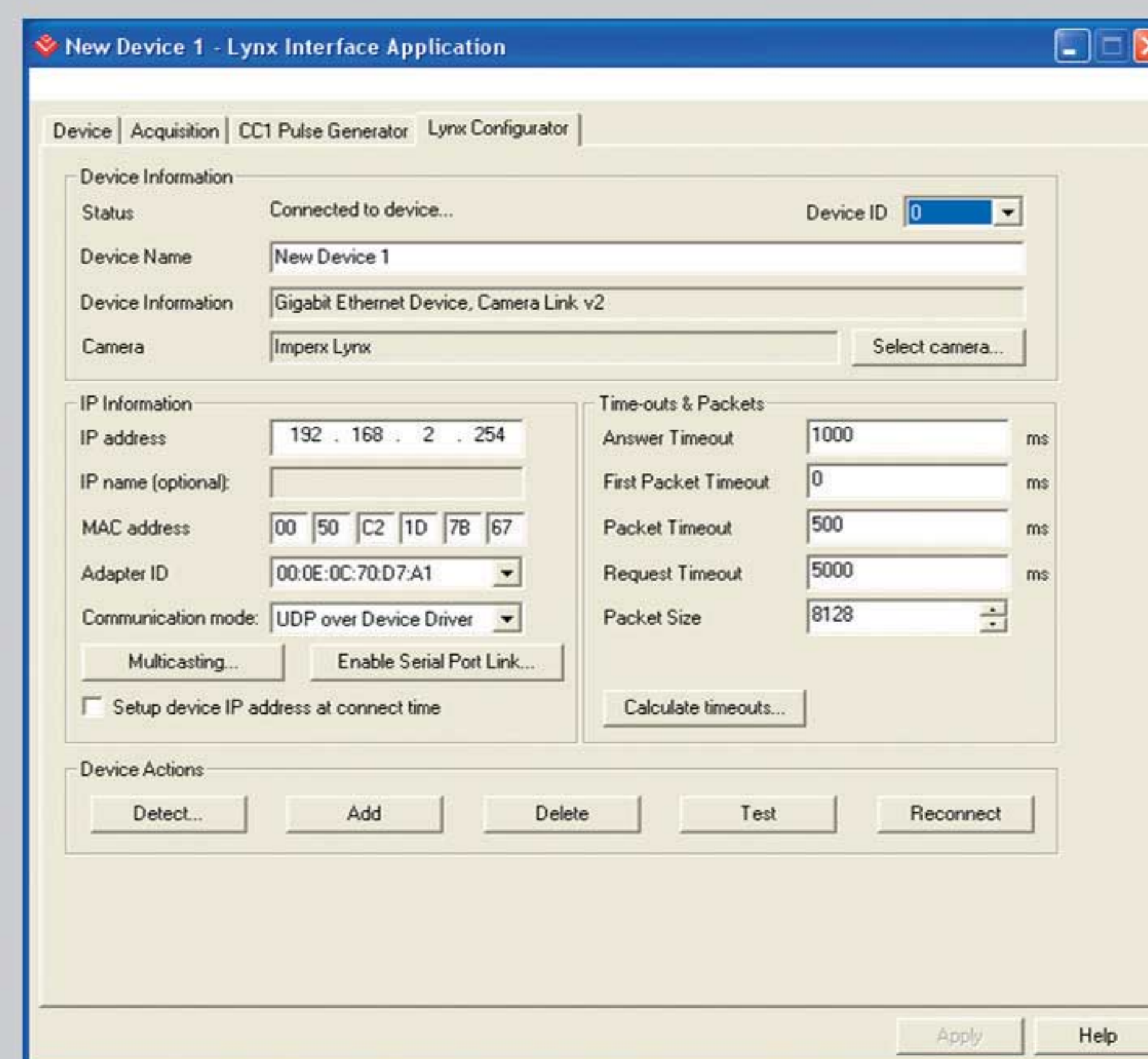

- Integrated software tools:
 - data acquisition and display
 - camera control and communication
 - camera configuration utility
 - triggering waveform generator
- Support for Labview, Image Pro, Halcon, Video Savant, MIL, eVision, Common Vision, StreamPix, and others.
- C++ and VB SDK. Support for Windows 2000, XP, Vista, SuSe-10, Linux, and others.

Ordering: **IPX-1M48-GMxCB**

Camera Family	Options
G - LYNX GigE Family	N - silver housing
Sensor Type	B - black housing
M - Monochrome	I - Auto Iris
C - Color	Lens Mount
U - UV sensitive (no glass)	C - "C" mount (default)
S - Special - user filter	F - "F" mount
	O - Open frame

For specific details and ordering information, consult the camera user's manual or contact us at sales@imperx.com.

Copyright © 2005, Imperx, Inc. Product information subject to change without notice.

Rev. 2.0, 05/01/06



Imperx Incorporated • 6421 Congress Avenue • Boca Raton, FL 33487 • USA
 Phone: 1-561-989-0006 • 1-866-849-1662 • Fax: 1-561-989-0045
www.imperx.com • sales@imperx.com

Made in USA

